

# Sky030 / technical data sheet

## STEEL COLOURS

WHITE, BLACK  
OR IRON GRAY



Sky030 staircases are characterized by a landing which allows the staircases to be fitted to openings without a hole or with a square opening. Sky030 has an adjustable height from 99 5/8" to 120 1/2" (from 253 to 306 cm).

Table 1

			ADDITIONAL ARTICLES	
	STAIRCASE HEIGHT IN CM	RISES	TREADS	POLES
INCREASE	132 1/16" - 148 7/16" 337 - 377 cm	16	+ 3	+ 1
	124 7/16" - 139 316 - 353 cm	15	+ 2	+ 2*
	116 1/8" - 129 15/16" 295 - 330 cm	14	+ 1	-
STANDARD	107 7/8" - 120 1/2" 274 - 306 cm	13	12 TREADS + 1 LANDING + RAILING WITH VERTICAL BALUSTERS	
DECREASE	99 5/8" - 111 7/16" 253 - 283 cm	12	-	-
	91 3/16" - 101 15/16" 232 - 259 cm	11	-	+ 1*
	83 1/16" - 92 19/16" 211 - 236 cm	10	-	+ 1*



ADJUSTABLE RISE FROM 8 5/32" TO 9 1/4" (FROM 21 TO 23,5 CM)

\* REPLACES THE EXISTING 49 3/16" (125 CM) POLE IN THE SKY030 STAIRCASE.

### D 47 1/4" (Ø 120 cm)

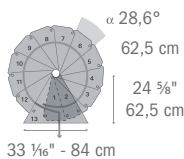

### D 55 1/8" (Ø 140 cm)

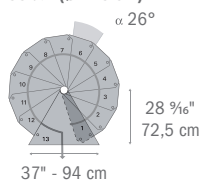

### D 63" (Ø 160 cm)

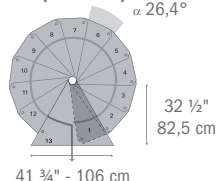

### DIAMETERS

The diameters of the staircase are 47 1/4", 55 1/8" e 63" (120, 140 e 160 cm). The recommended opening in the floor is at least 2" (5 cm) larger than the diameter of the staircase. Example: D staircase 47 1/4" (Ø 120 cm) = D ceiling opening 49 1/4" (Ø 125 cm).

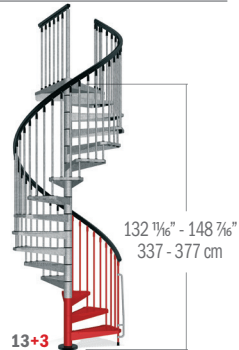
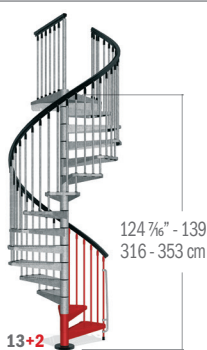
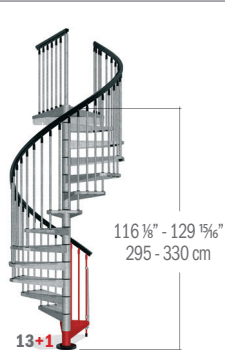
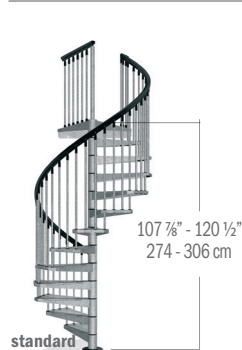

## SUPPLEMENTARY ITEMS OVERVIEW



### TYPES OF OPENINGS AND BALUSTRADES

mezzanine

fig. 1



square opening

fig. 2



### ROTATION

The direction of rotation, whether clockwise or anti-clockwise, can be decided during installation.



clockwise



anti-clockwise

### RESISTANCE TO WEATHERING



### RISER BAR

Allows to reduce the space between treads for safety.

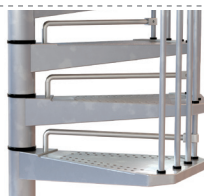

### BALCONY RAIL KIT

It is necessary to protect the upper floor aperture (fig. 1, 2).

It comes in 47 1/4" (120 cm) modules comprising 10 balusters, handrail and fixings.

### ATTENTION!

Do not assemble more than **one** 47 1/4" (120 cm) **module** at a time.

### ADDITIONAL TREADS / POLES

To reach a staircase height of 139" (353 cm), you must purchase one or more supplementary treads comprising the structure, tread and balusters.

Supplementary pole modules (Table 1) must be purchased for certain configurations.

The D 63" (Ø 160 cm) Sky030 complies to the: **INTERNATIONAL RESIDENTIAL CODE**

### 2012 - STAIR BUILDING CODE

Rise from 8 1/2" to 9 1/4"

(21 to 23,5 cm)

Minimum run at 12" (30,5 cm)

from the narrow edge: 7 1/2" (19 cm)

Clear width: 26 1/8" (68,5 cm)

Distance between railing balusters:

4" (10,2 cm)

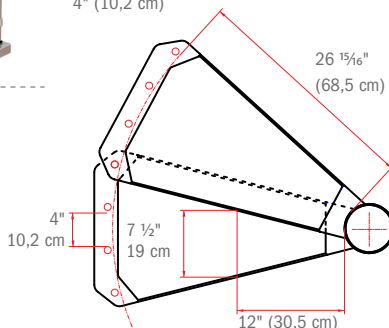

### EXAMPLE

If you wish to purchase SKY030 comprising 13 + 3 = 16 rises (see adjacent drawing), the following items are needed:

**1 SKY030 STAIRCASE** (standard)  
**3 ADDITIONAL TREADS**  
**1 ADDITIONAL POLE**  
**(32 3/8" / 82 cm)**



FOR FURTHER INFORMATION  
 VISIT THE WEBSITE  
[www.arkestairs.com](http://www.arkestairs.com)

fontanot  
arke